

TOSHIBA LIGHTING PRODUCTS (FRANCE) S.A

<p>1. Operating condition</p> <p>1-1. Temperature at sealing part: Temperature at both sealing ends (in the quartz glass above the molybdenum foil center) shall be measured with thermo-couple and must not exceed 350°C (to avoid a loss of electrical conductivity caused by molybdenum foil oxidation)</p> <p>1-2. Temperature at glass tube surface: 250 to 900°C</p> <p>1-3. Operating atmosphere: Under normal atmosphere pressure, without corrosive or explosive or inflammable gas.</p> <p>2. Storage environment</p> <p>2-1. Temperature range: -20°C MIN. 70°C MAX.</p> <p>2-2. Humidity range: 10%RH MIN 90%RHMAX without condensation.</p> <p>2-3. Under normal atmosphere pressure, without corrosive gas.</p>	<p>3. Warrantee</p> <p>3-1. Warrantee period: One year after the invoiced date to the customer.</p> <p>3-2. Condition of warrantee: In case of infrared heater lamp(s) with defect (defined as none-conformity to the specifications) is returned from the customer, during the warrantee period, TOSHIBA Lighting products (France) S.A., will compensate with re-delivering good infrared heater lamp(s). There is no obligation if the problem happened due to miss-design of appliances including safety design, miss-usage or miss handling of the infrared heater lamp(s). In case doubts rise up to judge none-conformity to the specifications, both parties shall cooperate together to solve problems.</p>
---	--

Batch code information:

Batch code example

A 0 6

Month	Code
Jan	A
Feb	B
Mar	C
Apr	D
May	E
June	G
July	H
Aug	K
Sept	L
Oct	R
Nov	S
Dec	U

Year	Code
2006	06
2007	07
2008	08
2009	09
2010	10
2011	11
2012	12
2013	13
2014	14
2015	15
2016	16
Etc..	

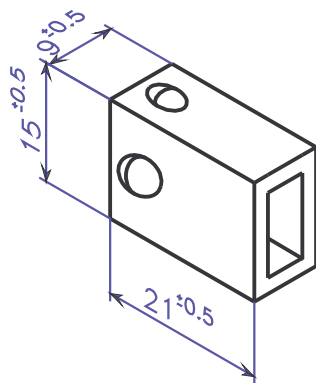
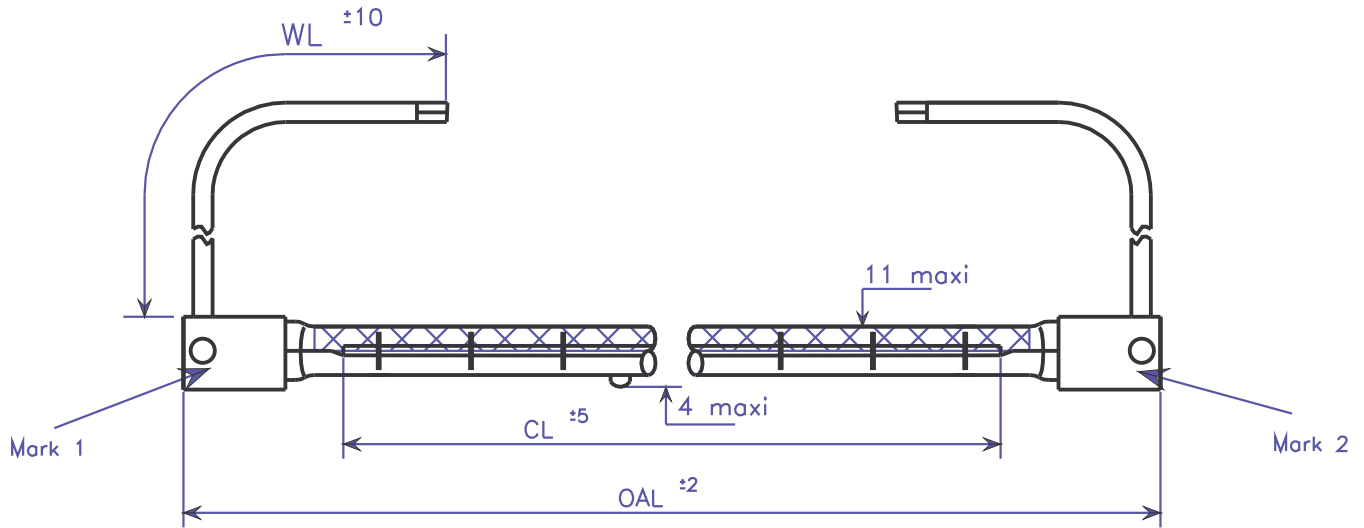

OAL	275		
CL	210	Mark 1	TOSHIBA France + lot
WL	600	Mark 2	JHC220V1000W210BFH

Wire: SILIFLON UL 1727 AWG 18 600V 250°C (blanc)
OMERIN or equivalent

Terminal: End stripped (7 mm)

Specifications:

Nominal voltage: 220 V

Wattage: 1000 W ± 5%

Average life: 5000 Hrs (with AC power supply, 50 or 60 Hz,
continuously at room temperature and free from vibration)

Lighting position: Horizontal ± 4°

Tc 2500 K

Strength test:

- Wire harness shall withstand tensile load of 5 Kgf

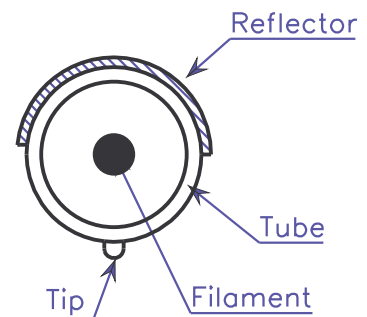

Type: InfraRed Halogen Heater Lamp
JHC 220V 1000W 210 BfH

Modif.:

Date:

Date:
12-01-06

TOSHIBA LIGHTING PRODUCTS
(France) S.A.

Version
EM-824

Comments