



**DR. FISCHER**  
Europe s.A.s.

A company of DR. FISCHER Group

## Infrared Halogen Lamps



## EMEA

### Germany, Austria, Switzerland & East Europe

**Sales Manager**

Tel. : +49 (0) 64 32 91 31-33

Fax: +49 (0) 64 32 6 20 69

diez.sales@dr-fischer-group.com

**Order Desk**

Tel. +49 (0) 64 32 91 31-31

Fax +49 (0) 64 32 91 31-41

diez.orderdesk@dr-fischer-group.com

### UK & Spain

**Sales Manager**

Tel. +33 (0) 3 83 80 30 21

Fax +33 (0) 3 83 80 30 48

fg.sales@dr-fischer-group.com

**Order Desk**

Tel. +33 (0) 3 83 80 30 60

Fax +33 (0) 3 83 80 30 48

pam.orderdesk@dr-fischer-group.com

### France, Italy, Sweden & rest of world

**Sales Manager**

Tel. +33 (0) 3 83 80 30 18

Fax +33 (0) 3 83 80 30 48

fm.sales@dr-fischer-group.com

**Order Desk**

Tel. +33 (0) 3 83 80 30 60

Fax +33 (0) 3 83 80 30 48

pam.orderdesk@dr-fischer-group.com

## AMERICA

### North America

**Sales Manager**

Tel. +33 (0) 3 83 80 30 21

Fax +33 (0) 3 83 80 30 48

northam.sales@dr-fischer-group.com

**Order Desk**

Tel. +33 (0) 3 83 80 30 60

Fax +33 (0) 3 83 80 30 48

pam.orderdesk@dr-fischer-group.com

## ASIA & PACIFIC REGION

### Asia & Pacific

**Sales Manager**

Tel. +82 70 8666 1637

Fax + 82 70 8282 1636

hc.son@dr-fischer-group.com

**Order Desk**

Tel. +82 70 8666 1638

Fax + 82 70 8282 1636

mk.im@dr-fischer-group.com

**DR. FISCHER Europe S.A.S.**

**Chemin de Montrichard**

**54700 Pont à Mousson**

**FRANCE**

Tel.: +33 (0) 3 83 80 30 60

Fax: +33 (0) 3 83 80 30 48

Internet: [www.dr-fischer-group.com](http://www.dr-fischer-group.com)

This catalogue is valid for 2011/2012

All technical data, dimensions and illustrations are non-binding.

We reserve the right to make alterations in construction. We assume no liability for printing errors.

The current terms of delivery and payment of DR FISCHER Europe S.A.S. apply.

Design: synergie werbung & kommunikation, [www.netzwerk-synergie.de](http://www.netzwerk-synergie.de)

<b>Contacts</b>	<b>2</b>
<b>DR. FISCHER Group</b>	<b>4</b>
<b>DR. FISCHER Europe S.A.S.</b>	<b>6</b>
<b>Competence and partnership</b>	<b>7</b>
<b>Technical support: open to the future</b>	<b>8</b>
<b>Infrared solutions</b>	<b>9</b>
<b>Technical information</b>	<b>10</b>

## **Industrial solutions**

Infrared halogen lamps for industrial applications	14
Infrared halogen lamps for plastics forming applications	15
High-power heat for the semiconductor industry	16
A clean and compact heat source for food warming	17
Overview industrial solutions: lamps, applications, caps and connections	18

## **Lamps for industrial solutions**

SK11	Standard lamps	19
SK 15	Clear sleeve lamps	19
SK 15	Speedium lamps	19
SK 15	Standard lamps	20
R7s	Standard lamps	21
X-clip	Standard lamps	22
X-clip	HeLeN lamps	22
U-clip	Standard lamps	23
U-clip	HeLeN lamps	23
V- cap	Standard lamps	24
V- cap	Facetted lamps	24

## **Comfort Heating solutions**

Infrared halogen lamps for Comfort Heating	26
Benefits of our Comfort Heating solutions	27
Outdoor applications	28
Indoor applications	29
Infrared cabins & saunas	30
Overview Comfort Heating solutions: lamps, applications, caps and connections	31

## **Lamps for Comfort Heating solutions**

SK 15	Weatherproof HeLeN lamps	32
SK 15	Standard HeLeN lamps	33
R7s	Standard HeLeN lamps	34
R7s	Economy Gold lamps	34
SK 15	Vitae lamps	35

<b>Accessories</b>	<b>36</b>
--------------------	-----------

<b>Symbols</b>	<b>37</b>
----------------	-----------

## The DR. FISCHER Group – Competence, Innovation, Service

The DR. FISCHER Group is one of the leading providers of lamps and lights. The various companies of the Group complement each other with their individual specializations and together form a competent, innovative and fair partner for customers and suppliers.

It is especially our structure as a group of specialized, traditional companies which enables us to satisfy the needs and requirements of our customers and provide precise and immediate solutions. Among our greatest strengths are competent advice, customer proximity, professional service and the creation of customized, user-related special applications.

With our constellation of highly competent special lamp manufacturers, our comprehensive portfolio within this sector and the attractive product range of KANDEM Leuchten GmbH for lights and lighting solutions, we offer a broad spectrum of products for the professional use of light.

The DR. FISCHER Group came about in the course of the last 20 years as the result of three family companies growing together: Speziallam-

penfabrik DR. FISCHER GmbH, Kegler Lichttechnik GmbH and Kandem Leuchten GmbH. The individual companies, with their specialist fields, are a perfect complement to each other. This makes it possible to fulfil customers' wishes and requirements precisely, quickly and in a solution-orientated manner. The greatest strengths of the group are tailor-made special applications and specific all-round solutions.

With manufacturing facilities in Turin, Diez by Frankfurt and Pont à Mousson, and more than 550 employees, the DR. FISCHER Group is an important producer of special lamps and lights.

With sales offices in Europe, Asia and South Africa, the group is active worldwide. The product portfolio includes traffic signal lamps for streets, railways, air and waterways; special lamps for medicine and research; household lamps for ovens, cooker hoods and refrigerators; lights and now infrared halogen lamps and solutions.

 **DR. FISCHER**  
Speziallampenfabrik GmbH

 **DR. FISCHER**  
Speziallampen Vertriebs GmbH

 **DR. FISCHER**  
Europe s.A.s.

 **DR. FISCHER**  
Italy s.r.l.

 **KEGLER**  
Lichttechnik GmbH

 **KANDEM**  
Leuchten GmbH

 **DR. FISCHER**  
LED GmbH

 **DR. FISCHER**  
Asia Pacific Ltd.



*We are certified for quality and environmental management.*





Pont à Mousson (France) is the headquarter of DR FISCHER Europe S.A.S., the production center of infrared halogen and high-voltage lamps.



The location at Diez is the main production centre for low-voltage lamps.



Up: DR FISCHER Italy s.r.l. produces special lamps for the domestic field at the Alpignano (Italy) location

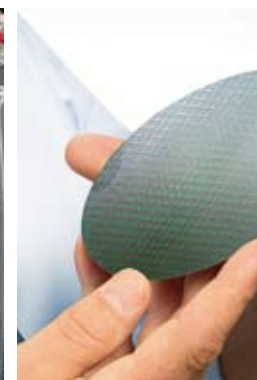
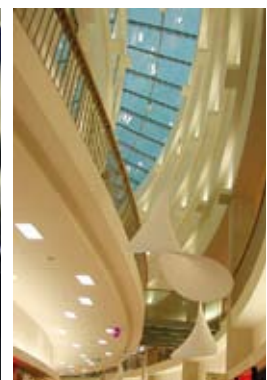

## The Pont à Mousson factory: a wealth of experience in lamp production

The production of lamps started in 1886 in Pagny sur Moselle, France with Mr. Fabius Henri on starting the first production of incandescent lamps.

Later on, in 1931, the factory joined the FRLE, a group of French lamp factories, owned 50 % by Philips and 50 % by the Mazda group.

In 1981, the factory moved to Pont à Mousson (10 km away) and became "Philips Eclairage" in 1985.

In 1989, the production of infrared halogen lamps started in Pont à Mousson with a dedicated area for this new activity. From this time, Philips Eclairage started developing innovative products like our famous HeLeN range.

On January 1st, 2008 the DR. FISCHER Group took over the incandescent activities of Philips in Pont à Mousson and founded DR. FISCHER Europe S.A.S. Here special lamps with high voltage technology are produced by using technically highly developed machines.

In 2010, DR. FISCHER Europe S.A.S. took over the whole site of Philips Pont à Mousson. By this acquisition, we strengthened our halogen production with high speed machines, and we now

offer an infrared portfolio with marketing/sales and distribution services. This means that one of the biggest centres of competence and production for infrared lamps and solutions is now located between Metz and Nancy.

The integration of Philips' entire field of activities in infrared and of all its employees means that the DR. FISCHER Group in Pont à Mousson now has comprehensive competence for special infrared light solutions – from research and development and quality assurance and production to marketing and sales. This unique synergy of the latest technology, experienced and motivated employees, tried and trusted procedures, flexibility and many years of experience in creating specific solutions together with the customer makes us the ideal partners in seeking future applications and solutions.

Infrared halogen lamps are used for comfort heating applications (terraces, warehouses, swimming pool heating), wellness (saunas) and many industrial applications such as painting, thermoforming, paper drying...

Innovative infrared applications will become

increasingly important in many industrial processes: paper processing and printing, the food industry, plastic manufacturing and processing, automobile production, glass processing and machining, the textile industry, the semicon and solar cells industry, wood processing and many others.

Our experience and know-how mean that we can be competent, thinking partners for our customers in the development and realisation of such innovative infrared solutions.



## Competence and partnership for your ideas

DR. FISCHER Europe S.A.S is more than just a manufacturer of high-quality infrared halogen lamps. We see ourselves as a full-service partner for our customers – whether you are manufacturers of heating units or lights, wholesalers or system integrators. Our aim is always to maximise the benefit for the end customer.

For that purpose, our Infrared Halogen Lamps Business Line has an integrated team that is ready to meet your needs: from innovation and development through production, logistics, marketing and sales right up to continuing customer support.

The basis is the convincing quality of our infrared halogen lamps designed to use short and medium wave infrared applications. We also offer all the technical and application support and customer service you need to integrate these products into your own applications. Our experience, product and application knowledge and various customer services are available to you, our partner, to enable you to maximize your competitive strength. Excellent quality combined with our service based approach is what our customers and partners appreciate about us.

### Understanding

We believe that working in strong partnership with our selected OEM partners and close collaboration is the best way for us to understand your products, service and innovation needs. This is why our approach is based on a close working relationship to enable us to meet your needs most effectively.

### Expertise

Our expertise in infrared applications can support your innovations in helping you design heating solutions.

Our infrared application system support tool was created to give you the best possible infrared halogen lamp solutions and technical support in designing your heating solution.

### Testing

When designing an infrared heater, it is highly important to check that its performance matches the requirements of the application. To help our OEM partners to assess and optimize the quality level of their heating system, our application team proposes specific measurement.

### Quality

Our quality department closely monitors technological developments in infrared halogen lamp integration during product design and manufacturing to enable us to provide you with optimal support in continuous product improvement.

### Contacts

Our worldwide presence and resources make us the ideal partner in the global marketplace. This means we are in a position to support you wherever your location is.

### What we can bring to our customers:

- high-quality products and services
- competence and experience in innovative research and development
- willingness and ability of cooperation with our customers
- technological resources and equipment that is state of the art
- strong knowledge about the possibilities of infrared use
- usable market knowledge
- professional after-sales service

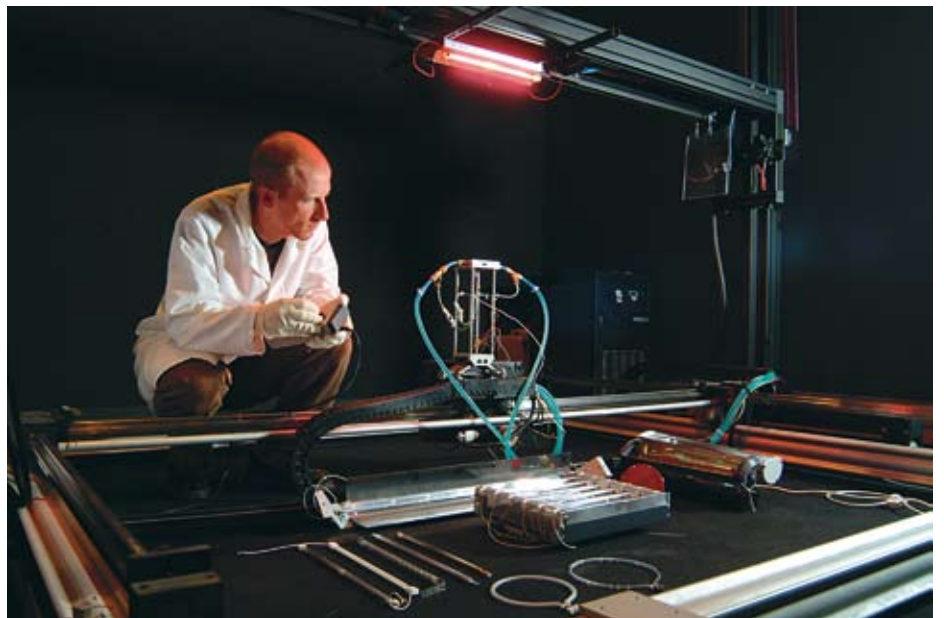

## Our technical support: open to the future

We, DR. FISCHER Europe S.A.S., want to be more to our customers than just a provider of high-quality infrared halogen lamps. We believe that working together in close collaboration is the best way for us to understand your products, service and needs for innovation. This is why our approach is based on a close working relationship to enable us to meet your needs more effectively.

Our aim is to increase the added value that helps you as a specialist supplier, fixtures manufacturer or complete system integrator, to move forward.

We are committed to offering you a world class service in every aspect of our business. That includes not only the best infrared halogen lamp solutions, but also the matching technical and application support as well as service. That combination of products, support and service is what makes us your potential closest partner today.

For more than 20 years, the DR. FISCHER Group has been a major player on the very special lighting market, applying its expertise and advanced technology to the creation of innovative infrared solutions for all kinds of heating, drying and cooking applications.

Our expertise in infrared applications can support your innovations in helping you design heating solutions.

When designing an infrared heater, it is vitally important to evaluate its performance against the application requirements.

- DR. FISCHER in Pont à Mousson (France) is equipped with a unique Spatial Irradiance Measurement bench (XY bench). This enables us to evaluate and qualify the irradiance (heat output) of lamps, heaters and industrial infrared systems.
- Based on the needs of our customers, we are able to provide advice on specific matters such as reflector geometric optimization. The accuracy of the results is ensured by the use of a specific measurement control system.
- Measurements are conducted in a black chamber to eliminate any disturbances. The lamp voltage and fluxmeter temperature are under constant control during measurements.

Reducing time to market in the development of new systems is essential. The specific PH3D

optical modeling software, based on an efficient 3D ray tracing method, is used to optimize our customers' high-performance infrared systems and solutions.

Using these tools, our infrared modeling support activities can address three main topics:

- Improvement or upgrading of existing reflectors or systems
- System configuration issues, such as lamp specifications and arrangement, installed power, sizing etc.
- Design of new reflectors to reach the defined heating specifications

Our DR. FISCHER infrared modeling support allows our customers to predict system irradiance (heat output) by simulation without the need for any tooling or prototyping. This enables predictive, quantitative results to be achieved at a reasonable cost. The validity of modeling outputs is assured by a regular calibration. Our infrared R&D team always provides accurate quotation for each project you have.

### Infrared modeling support

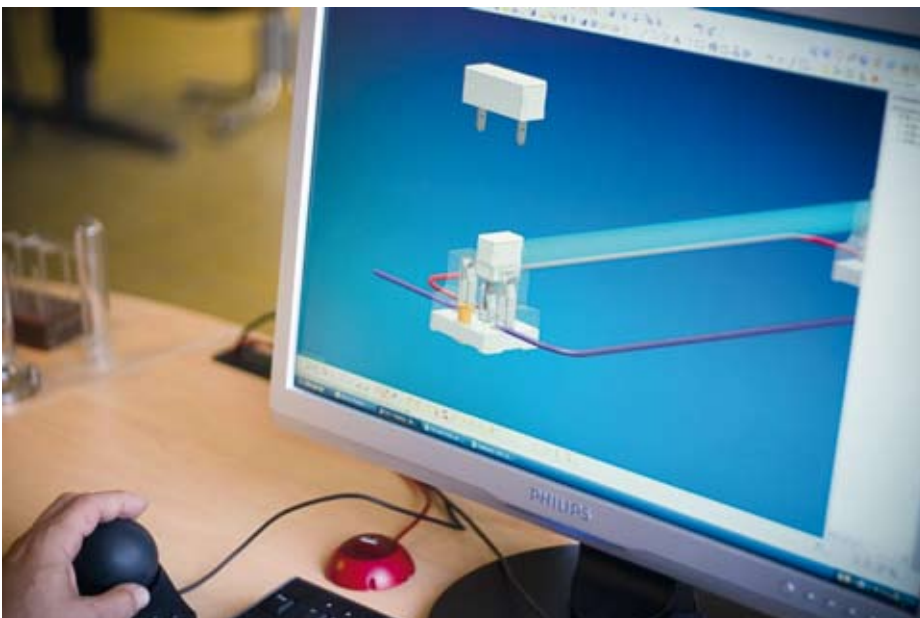
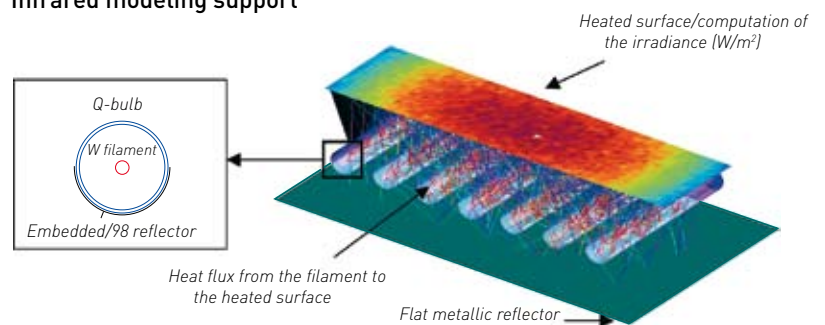



## DR. FISCHER infrared solutions

The most varied of manufacturing processes require heat: heating, drying, evaporating, shaping, gel formation, softening, tempering, adhering, activating, baking, laminating, disinfecting, conserving ...

Industrial post-production processes undergo permanent rationalisation. The degree of automation is constantly on the increase, as are production figures. Innovative, effective and cost-reducing solutions are necessary to survive in this competitive atmosphere.

Infrared light transfers heat without direct contact or convection; this means it can always be used wherever these things must be avoided. Furthermore, heat transfer via infrared is fast and energy efficient. DR. FISCHER infrared halogen lamps are an ideal source of infrared light. With DR. FISCHER infrared halogen lamps, heat can be targeted and directed with precision. On account of their extremely fast switchability, DR. FISCHER infrared halogen lamps can also be integrated into processes that require short and fast heat feed.

DR. FISCHER infrared halogen lamps are the optimum solution in a wide range of industrial applications that require short or medium-wave infrared.

DR. FISCHER infrared halogen lamps are suitable for paper processing, printing, the food industry, plastic manufacturing and processing, automobile production, glass processing and machining, the textile industry, the semiconductor industry, wood processing and many others.

A further field of use for infrared halogen lamps is comfort heating. This includes both use in infrared cabins and use to heat ambient air.

The infrared halogen lamps are suitable for use inside and outside: DR. FISCHER infrared halogen lamps provide comfortable warmth immediately after they have been switched on: on patios and in yards, in hotel rooms, in assembly halls and at workplaces in public buildings and even in large open spaces or sports facilities.

Since the heat energy of infrared halogen lamps is emitted in the form of radiation, the energy is used to heat directly an object or person at which

it is directed without heating the surrounding air. This is what makes DR. FISCHER infrared halogen lamps a highly efficient heat source.

### Overview of applications

Application	Lamp solution
Plastic forming	Standard and Speedium
Bottle blowing	White coated and standard
Paint	Standard and HeLeN
Paper	High power standard
Food catering	Clear sleeve
Food processing	Standard
Semiconductor	High power compact
Outdoor spaces	Weatherproof and Standard HeLeN
Wet environment	Weatherproof HeLeN
Indoor spaces	Standard HeLeN and Eco gold coated
Replacement market	Standard HeLeN and Eco gold coated
Infrared cabins	Vitae
Bodycare application	Standard HeLeN and Vitae

### Basic benefits of infrared halogen lamps

- 90% of the heat is available within one second (no pre-heating)
- 90% of the energy used is converted to IR heat
- can be directed using reflectors, meaning that even small partial areas can also be heated effectively
- intensity is continuously variable from 0 - 100%

The most modern and sophisticated technology makes infrared halogen lamps reliable and safe:

- life of up to 5,000 hours independently of the cycles of operation
- no emission formation
- no oxygen consumption
- no pollution from air or dust movement
- no odor

# Infrared heating principles

DR. FISCHER infrared halogen lamps are designed and used for all kinds of heating and drying applications.

Basically there are three main heating principles:

## Conduction

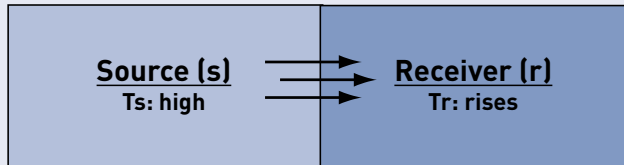

Heat transfer is made through direct contact from the source to the object.

## Convection

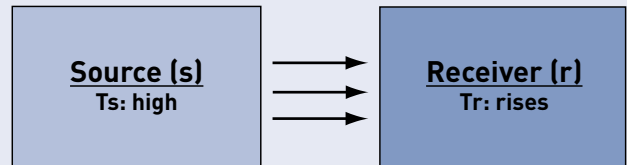

Heat transfer is made by a flow of liquid or gas (air), primary heated by a source.

## Radiation

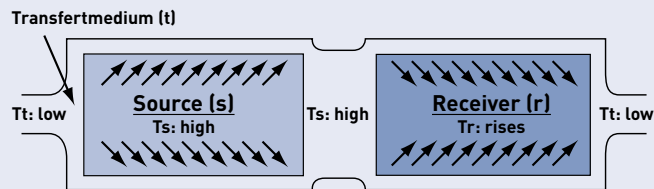

The heat transfer doesn't require a medium. The heat radiation generated by the source interacts directly with the receiver which heats up.  
Eg: Warm feeling of a sun beam touching your face at winter time.

DR. FISCHER infrared halogen lamps use this radiation principle. They directly heat an object or person at which they are directed without heating the surrounding air. This is what makes them highly efficient heat sources.

# Infrared within the optical spectrum

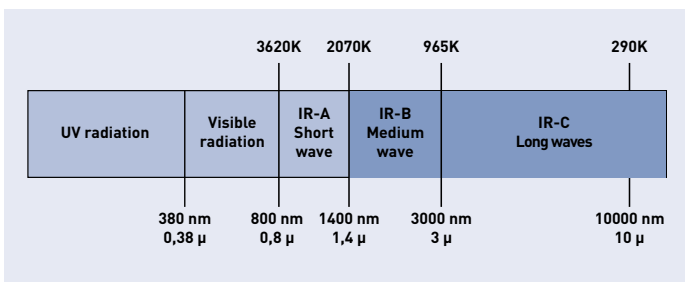

The infrared part of the optical spectrum is split into three parts:

- Short wave: IR-A
- Medium wave: IR-B
- Long wave: IR-C

## Emission Spectrum

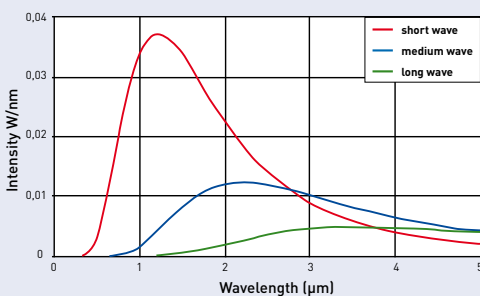

DR. FISCHER has a lot of short and medium wave emitted infrared halogen lamps in its product range.

## The infrared wavelength and their differences

The radiation in the three wavelength ranges has a number of differences which are shown in the table below. This table shows that infrared emitters (heat sources) radiate their energy over a range of wavelengths.

This means that DR. FISCHER infrared halogen lamps meet the requirements of very many applications because of their outstanding effectiveness and extremely fast switchability.

The main range of DR. FISCHER infrared halogen lamps emits short and medium wave radiation.

Infrared wave	Short wave	Medium wave	Long wave
Emitter	Infrared halogen lamp	Infrared halogen lamp / Quartz emitter	Resistance
Material	Tungsten coil in sealed quartz tube	Fe-Cr-Al alloy in quartz tube	Fe-Cr-Al alloy in closed steel tube
Radiant efficiency	92%	60%	40%
Switch ON/OFF time (90% output)	1 sec	30 sec	5 min
Emission peak	1,2 µm	2,2 µm	4,0 µm
Visible	6%	0,5%	0,05%
IR-A	34%	3,5%	1%
IR-B	50%	50%	14%
IR-C	10%	46%	85%
Colour temperature	2500 K	1300 K	800 K
Heating principle	Radiation	Radiation and convection	Convection
Air draught sensitivity	No	High	Very high
Focusing with reflectors	Good focusing recommended	Possible	Hardly not relevant
Colour sensitivity	High	Medium	Low

## DR. FISCHER infrared halogen lamps

DR. FISCHER infrared halogen lamps cover a wide range of uses. They are suitable for a multitude of applications, such as comfort heating, semiconductor industry, bottle-blowing, thermoforming, infrared heating cabins, car paint drying, food warming etc.

Our infrared catalogue presents all our infrared halogen lamps for various applications. In addition to these standard products, we also supply a number of lamps designed to meet the specific requirements of our key partners.

### Key benefits of DR. FISCHER infrared halogen lamps

Features	Benefits
Instant heat	Full emitted power within milliseconds after switch-on
No emissions or pollution	Clean and environmental friendly
Quartz envelope for infrared halogen lamps	Heat shock resistant and safe
90% of the energy is transmitted as infrared heat	Efficient and economical heat source
Dimmable	Output accurately controllable from 0 to 100% to match your needs
Infrared halogen technology	No blackening of the bulb and so no depreciation infrared emission during life time.
Long lifetime	Low maintenance
Same optical properties as light	Heat can be focused by reflectors
Compact design	Allows design of compact heat sources and systems

# Integration rules

## Standard permissible temperatures

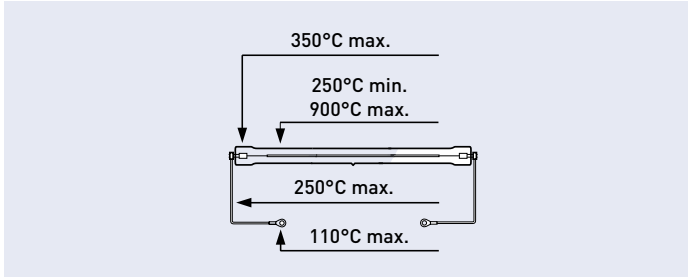

## DR. FISCHER infrared halogen lamps with HeLeN technology permissible temperatures

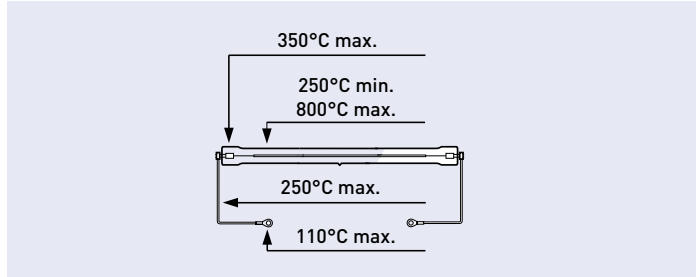

### Recommendations:

- To avoid pinch damages: pinch temperature has to be inferior to 350°C/662°F
- To ensure a proper halogen cycle: tube temperature has to be superior to 250°C/482°F
- To avoid tube damages: tube temperature has to be lower than 900°C (1652°F) and lower than 800°C (1472°F) for HeLeN

## Lamp power and colour temperature as a function of voltage in percentage of nominal values

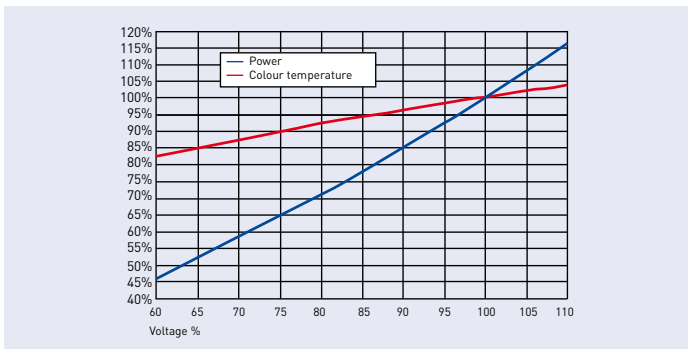

Power and colour temperature of the lamp quickly vary according to the voltage.

## DR. FISCHER infrared halogen lamps with HeLeN technology glare reduction filter

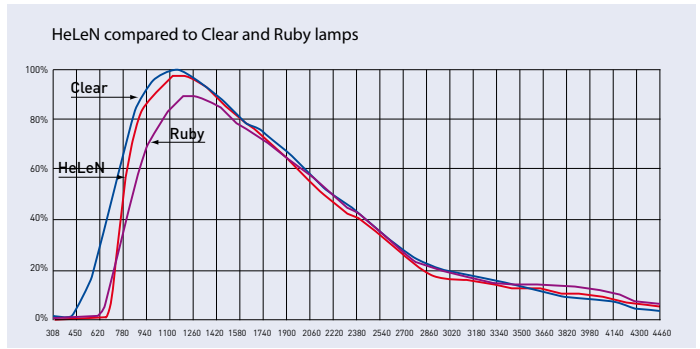

Remark: 100%=maximum irradiance level of the clear lamp

DR. FISCHER infrared halogen lamps with HeLeN technology a glare reduction filter, which cuts „visible light” part of the spectrum and has almost the same efficiency and the same heat radiation as the equivalent clear lamp.

## The emission spectra of infrared halogen lamps with and without reflector

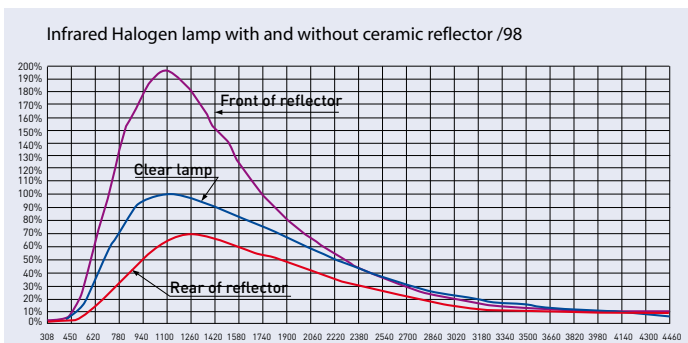

Remark: 100%=maximum irradiance level of the clear lamp

The heat radiation level obtained in front of an embedded reflector is two times the level of the equivalent clear lamp.

## Embedded reflector

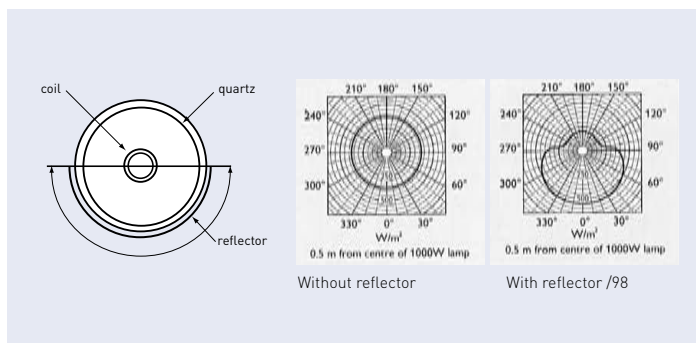

The reflector directs heat radiation in one direction from 180° towards five desired areas.



## DR. FISCHER infrared halogen lamps for industrial applications

DR. FISCHER infrared halogen lamps are the ideal, high-power heat source for a wide range of industrial heating applications such as paper processing, printing, metalworking applications, the food industry, plastic manufacture and processing, car manufacturing, glass processing and machining, the textile industry, the manufacture of solar installations, the semiconductor industry, wood processing and many other things.

These are halogen lamps, which means that tube blackening and resulting reduction in infrared output are negligible, ensuring very high process stability throughout the lamp lifetime. Full power is reached within a few hundred milliseconds of switch-on. Lamp power is fully controllable, with instant adjustment of the required heat level between 0 and 100%. DR. FISCHER infrared halogen lamps are compact heat sources.

**DR. FISCHER infrared halogen lamps are the optimal solution for numerous heating, drying and curing applications.**

Efficient, economical heating for a wide range of industrial applications	
Features	Benefits
90% of the energy is transmitted as infrared heat	Efficient and economical heat source
Dimmable	Output accurately controllable from 0 to 100% to match your needs
Infrared halogen technology	A clean, safe, compact and focusable heat source for a wide range of industrial applications

Applications
<ul style="list-style-type: none"> <li>• Paint drying in tunnels and body shops</li> <li>• Paper drying in paper mills</li> <li>• Powder coating</li> <li>• Drying of lacquers and printing links</li> <li>• Heat sterilization</li> </ul>

### Recommended lamps

Lamps for industrial applications	
Application	Lamp
Paint	Standard and HeLeN
Paper	High power standard



## DR. FISCHER infrared halogen lamps for plastics forming applications

DR. FISCHER infrared halogen lamps provide productive, energy-efficient heating for a wide range of plastics forming applications, such as bottle blowing, thermoforming and many more. New sheet processing technologies and the use of thermo formable materials greatly extend the range of products that can be formed. Thermoforming therefore maximizes creativity and versatility, making it a preferred process for plastic forming.

DR. FISCHER infrared halogen lamps increase productivity, with optimal versatility, safety and energy savings. Thanks to their high irradiance

output, DR. FISCHER infrared halogen lamps require lower installed power to transmit the same level of heat. This high efficiency means less power is required to provide the same material temperature compared with quartz or ceramic emitters. The instant heat reduces cycle time and increases higher process speed. DR. FISCHER infrared halogen lamps give a better temperature gradient through the plastic thickness for enhanced temperature homogeneity, which is a key factor in plastics processing. These infrared halogen lamps can be instantly adjusted to the required heat level simply by dimming, which means a more accurate, versatile process.

**DR. FISCHER infrared halogen lamps save time and money by improving and optimizing heating processes.**

### Lamps for versatile, energy efficient forming of plastics

Features	Benefits
Infrared halogen technology	A clean, safe and compact heat source for instant, efficient plastic forming
Dimmable	Output accurately controllable from 0 to 100% to match your needs
High irradiance output	Lower installed power needed than with quartz or ceramic emitters to create the same material temperature

### Applications

- Blowing of plastic bottles
- Plastics thermoforming
- Softening and melting of plastics

### Recommended lamps

#### Lamps for plastic forming applications

Application	Lamp
Plastic forming	Standard and Speedium
Bottle blowing	White coated and standard



## High-power heat for the semiconductor industry

Heating is a critical process in the manufacturing of semiconductor devices. We offer a wide range of infrared halogen lamps as heat sources for use in the key steps of silicon wafers production. DR. FISCHER infrared halogen lamps can answer the demanding new generation of processes used in the waferfabs thanks to their quality and long lifetime.

Heat transfer is operated by direct radiation from the lamp to the wafer. As both the lamp tube and the chamber are in quartz, they are transparent to short waves infrared, there are no losses of energy from the filament of the lamp to the wa-

fer. The lamps are halogen type so there is no blackening of the bulb and as a consequence no depreciation of infrared emission during the lifetime. In combination with reflectors, infrared radiation is evenly distributed to the wafer. The ability to easily vary the heat intensity provides valuable operating flexibility. Wafer temperature can be modulated accurately and allow design of high demanding processes. Rapid thermal responses: full emitted power is reached within hundreds of milliseconds. Power of the lamp is fully controllable; radiative power can be adjusted from 0 to 100% instantly.

**DR. FISCHER infrared halogen lamps deliver clean and compact solutions for advanced technologies.**

Lamps for precisely controllable semi-conductor heating	
Features	Benefits
Instant heat	Full emitted power within milliseconds after switch-on
Fully dimmable	Silicon wafer temperature can be modulated precisely and accurately over a wide range
Halogen technology	No blackening of the bulb and so no depreciation infrared emission during lifetime

Applications
<ul style="list-style-type: none"> <li>• Epitaxy</li> <li>• CVD (Chemical Vapor Deposit)</li> <li>• RTP (Rapid Thermal Process)</li> <li>• Ion implant annealing</li> <li>• Etching</li> <li>• Strip removal</li> </ul>

### Recommended lamps

Lamps for semiconductor industries	
Application	Lamp
Semiconductor	High power compact





## A clean and compact heat source for food warming

DR. FISCHER infrared halogen lamps for food warming are designed specifically for applications such as microwave ovens, food warming and catering. These tubular halogen heat lamps are highly economical as more than 90% of the consumed electrical power is converted into heat. Full power is reached within just one second and cooling is rapid. DR. FISCHER infrared halogen lamps allow stylish, appealing equipment designs. These compact heat sources have a long life and they are easy to keep clean.

DR. FISCHER infrared halogen lamps with clear

sleeves feature a double-jacket quartz envelope for total security and easy handling in food warming and catering applications. Maintenance is simplified as the lamp can easily be cleaned with a duster. And thanks to the low internal tube pressure, there is no risk of lamp explosion. Safety is key in the food preparation market! DR. FISCHER infrared halogen lamps with medium wave provide an ideal solution for the latest generation of high-performance cooking appliances with enhanced grill options. The specific medium wave spectrum ensures even heating.

**DR. FISCHER infrared halogen lamps are safe and offer versatile warming solutions.**

### Food warming lamps for controllable, economical heating

Features	Benefits
Envelope of quartz glass	Heat shock resistant
90% of the energy is transmitted as infrared heat	Efficient and economical heat source
Low internal tube pressure	No risk of lamp explosion
Infrared halogen technology	A clean, safe and compact heat source for food warming

### Applications

- Preparation of food in ovens
- Grilling function in microwave and conventional ovens
- Catering and food warming
- Fast baking

### Recommended lamps

Lamps for food warming	
Application	Lamp
Food catering	Clear sleeve
Food processing	Standard



## Lamps, applications, caps, connections

## Infrared halogen lamps for industrial applications

## Standard lamps

Tubular double-ended infrared halogen lamp used as high-power and high-efficiency heat source for various industrial applications. These lamps can incorporate an embedded white reflector which allows focusing the infrared radiation to the object. This large range of lamps matching all kind of industrial design thanks to many different connections and length. They are compact, clean and outstandingly energy-efficient.

These infrared halogen lamps are the technology of choice for a wide range of applications like heating, drying, curing, cooking and many more.

That's why increasing numbers of end-users are discovering the benefits of Infrared in applications from food preparation to semiconductor manufacturing, from automotive to glass processing and from paint drying to plastics forming.

## HeLeN lamps

The revolutionary DR. FISCHER HeLeN lamp is a unique heat lamp based on our world-leading technology and knowledge to meet the demanding needs of applications requiring direct heat and low-glare performance. The DR. FISCHER HeLeN heat lamps is a simple, effective and reliable heat source which is both energy-efficient and comfortable.

## Clear sleeve lamp

DR. FISCHER Clear sleeve lamps feature a double-jacket quartz envelope for total security and easy handling in food warming and catering applications. Maintenance is simplified as the lamp can easily be cleaned with a duster. And thanks to the low internal tube pressure, there is no risk of lamp explosion. Safety is key in the food preparation market.

## Facetted lamps

The particularity of these lamps is a special shape for some industrial applications.



## Speedium lamps

DR. FISCHER Speedium lamps use a new filament design to offer the best solution in plastic and curing applications. These lamps deliver more medium-wave heat to materials that are more sensitive to this wavelength. At the same time the DR. FISCHER Speedium lamps feature the key benefits of all our Infrared halogen lamp range: fast response, optimal controllability and focusing.







## Overview of applications

Application	Lamp solution
Plastic forming	Standard and Speedium
Bottle blowing	White coated and standard
Paint	Standard and HeLeN
Paper	High power standard
Food catering	Clear sleeve
Food processing	Standard
Semiconductor	High power compact

## Overview of caps

Cap type	
SK 11	
SK 15 SK 15 Weatherproof	
R7s	
X-clip	
U-clip	

## Overview of connections

Wire with	
Splice	
Fork	
Ring	
Faston	
Insulated tab	
Tab	
Special Terminal	

Standard lamps  
Clear sleeve lamps  
Speedium lamps

## Standard lamps SK 11

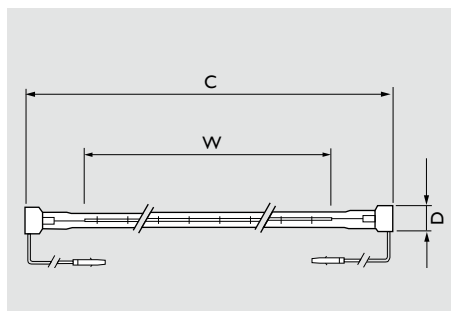

Medium wave

Watt	Volt	Total length max mm (C)	Heating length mm (W)	Bulb diameter mm (D)	Tube	Colour temp. K	Average life h	Burning Position	Terminal	Wire mm	PU	Type no.	Article no.
400	110	496	443	11	clear	1800	5000	horizontal	special	183/513 insulated	10	13296C	9239 470 31916
400	110	496	443	11	clear	1800	5000	horizontal	special	120/500 insulated	10	13296C2	9245 548 31916

## Clear sleeve lamps SK 15

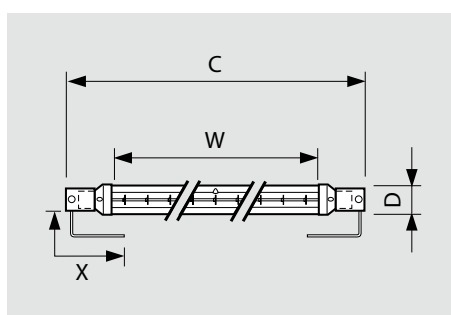

Short wave

Watt	Volt	Total length max mm (C)	Heating length mm (W)	Bulb diameter mm (D)	Tube	Colour temp. K	Average life h	Burning Position	Terminal	Wire mm (X)	PU	Type no.	Article no.
500	235	225	160	19	clear	2400	5000	horizontal	splice	230/230 insulated	10	13169Z/850	9245 523 44924

## Speedium lamps SK 15

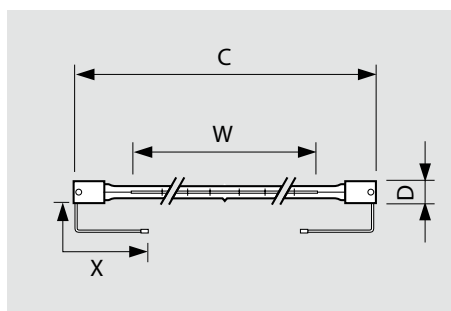

Medium wave

Watt	Volt	Total length max mm (C)	Heating length mm (W)	Bulb diameter mm (D)	Tube	Colour temp. K	Average life h	Burning Position	Terminal	Wire mm (X)	PU	Type no.	Article no.
200	60	97	40	11	with white reflector	1800	5000	horizontal	splice	250/250 insulated	20	17013Z/98	9245 625 26416
650	235	236	164	12	clear	1700	5000	horizontal	splice	140/140 insulated	10	17018Z	9245 698 44 916

## Standard lamps

## Standard lamps SK 15

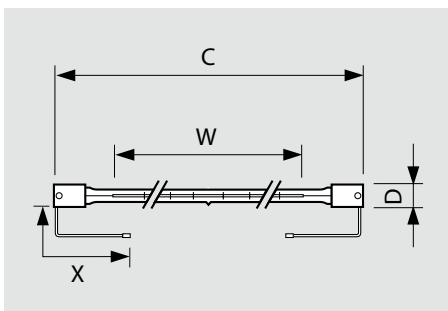

Short wave

Watt	Volt	Total length max mm (C)	Heating length mm (W)	Bulb diameter mm (D)	Tube	Colour temp. K	Average life h	Burning Position	Terminal	Wire mm (X)	PU	Type no.	Article no.
300	230	122	60	11	clear	2500	1000	horizontal	splice	140/140 insulated	10	13908Z	9245 271 44216
500	235	227	159	11	with white reflector	2300	5000	horizontal	fork	200/200 not insul.	10	13169Z/98	9238 527 44516
700	240	216	150	11	clear	2600	5000	horizontal	splice	140/140 insulated	10	13842Z	9245 270 45516
1000	235	355	272	11	with white reflector	2500	5000	horizontal	fork	200/200 insulated	10	13195Z/98	9238 543 44516
1000	235	355	272	11	with white reflector	2500	5000	any	fork	200/200 insulated	10	13713Z/98	9238 535 44516
1000	235	355	272	11	with white reflector	2400	5000	any	fork	300/300 insulated	10	13713Z/98L	9245 757 44916
1000	400	355	274	11	with white reflector	2500	5000	horizontal	fork	200/200 insulated	10	14187Z/98	9245 792 49116
1200	144	228	155	11	with white reflector	2400	5000	horizontal	fork	150/150 insulated	10	13561Z/98	9245 482 57716
1200	235	224	155	11	with white reflector	2600	5000	horizontal	fork	150/150 insulated	10	14134Z/98	9245 371 44916
1600	235	228	155	11	with white reflector	2600	5000	horizontal	fork	150/150 insulated	10	14135Z/98	9245 372 44916
2000	235	355	280	11	clear	2500	5000	Any	fork	200/200 insulated	10	13168Z	9245 717 44916
2000	235	355	280	11	with white reflector	2400	5000	horizontal	splice	230/230 insulated	10	14103Z/98	9245 347 44916
2000	235	355	280	11	with white reflector	2400	5000	horizontal	fork	200/200 insulated	10	13213Z/98F	9245 003 44516
2000	235	355	280	11	with white reflector	2600	5000	horizontal	fork	200/200 insulated	10	14136Z/98	9245 477 44916
2000	235	360	285	11	with white reflector	2400	5000	horizontal	ring	160/160 double insulated	10	14193Z/98	9245 842 44916
2000	235	355	280	11	with white reflector	2500	5000	any	fork	200/200 insulated	10	13168Z/98	9238 536 44516
2000	230	656	500	11	with white reflector	2500	5000	horizontal	splice	500/500 insulated	10	13214Z/98	9245 323 44216
2000	235	787	696	11	with white reflector	2300	5000	horizontal	splice	500/500 insulated	10	14132Z/98	9245 526 44916
2000	400	355	274	11	with white reflector	2600	5000	horizontal	splice	300/300 insulated	10	14173Z/98	9245 731 49116
2000	400	355	274	11	with white reflector	2600	5000	horizontal	fork	200/200 insulated	10	14188Z/98	9245 793 49116
2500	235	355	280	11	with white reflector	2600	5000	horizontal	fork	200/200 insulated	10	14137Z/98	9245 478 44916
2500	400	355	280	11	with white reflector	2600	5000	horizontal	fork	200/200 insulated	10	14143Z/98	9245 561 49116
3000	235	355	280	11	with white reflector	2550	5000	horizontal	splice	230/230 insulated	10	14121Z/98	9245 449 44916
3000	235	360	285	11	with white reflector	2550	5000	horizontal	ring	160/160 double insulated	10	14194Z/98	9245 843 44916
3000	230	787	700	11	clear	2400	5000	horizontal	splice	500/500 insulated	10	14107Z	9245 574 44216
3000	230	787	696	11	with white reflector	2300	5000	horizontal	splice	500/500 insulated	10	14107Z/98	9245 363 44216
3000	400	355	280	11	clear	2700	5000	horizontal	splice	230/230 insulated	10	14175Z	9245 736 49116
3000	400	355	280	11	with white reflector	2250	5000	horizontal	fork	200/200 insulated	10	14144Z/98	9245 562 49116

Standard lamps R7s and R7s + cables

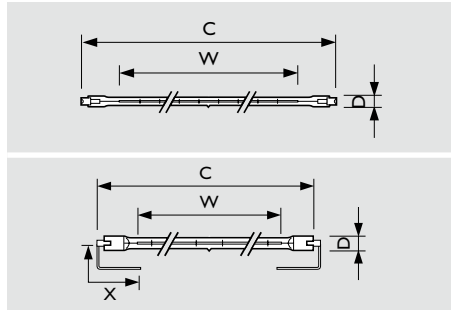

Short wave

Watt	Volt	Total length max mm (C)	Heating length mm (W)	Bulb diameter mm (D)	Tube	Colour temp. K	Average life h	Burning Position	Terminal	Wire mm (X)	PU	Type no.	Article no.
300	230	118	60	11	clear	2500	1000	horizontal	-	-	10	13908R	923 850 343 301
500	235	221	165	11	clear	2450	5000	horizontal	-	-	10	13169R	923 946 844 516
650	220	551	495	11	clear	2200	5000	horizontal	-	-	10	13790R	923 947 342 916
1000	110	204	126	11	with white reflector	2400	5000	any	fork	200/200 not insulated	10	13207/998	923 945 231 916
1600	240	499	406	11	trans-lucent	2550	5000	horizontal	-	-	10	1600T3/7	924 519 043 816
1600	600	732	418	11	clear	2700	5000	horizontal	splice	190/190 not insulated	10	13252/99	924 533 951 216
2500	400	600	506	11	with white reflector	2550	5000	horizontal	splice	300/300 not insulated	10	14140C/98	924 554 749 116
2500	480	731	418	11	clear	2550	5000	horizontal	-	-	10	14120R	924 543 851 716
2500	480	726	638	11	trans-lucent	2550	5000	horizontal	-	-	10	2500T3/7	924 519 151 616
2500	575	730	638	11	clear	2550	5000	horizontal	splice	146/146 not insulated	6	14168C	924 570 551 516
2500	600	1059	638	11	clear	2550	5000	horizontal	splice	146/146 not insulated	6	13848/99	924 529 151 216
3000	400	600	506	11	with white reflector	2550	5000	horizontal	splice	300/300 not insulated	10	14156C/98	924 562 849 146
3000	400	784	700	11	with white reflector	2450	5000	horizontal	splice	300/300 not insulated	10	14177C/98	924 574 449 116

## Standard lamps

## HeLeN lamps

## Standard lamps X-clip

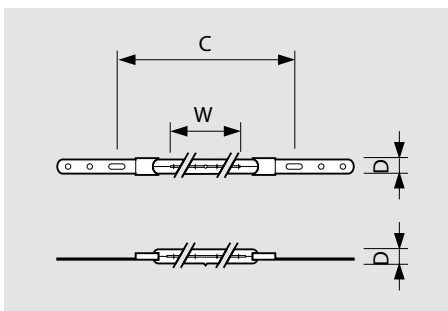

Short wave

Watt	Volt	Total length max mm (C)	Heating length mm (W)	Bulb diameter mm (D)	Tube	Colour temp. K	Average life h	Burning Position	Terminal	PU	Type no.	Article no.
500	120	355	142	11	clear	2450	5000	horizontal	X-clip	10	13169X	9238 500 32316
500	120	355	142	11	with white reflector	2350	5000	horizontal	X-clip	10	13169X/98	9238 502 32316
1000	235	483	272	11	clear	2500	5000	horizontal	X-clip	10	13195X	9238 510 43916
1000	235	483	272	11	with white reflector	2400	5000	horizontal	X-clip	10	13195X/98	9238 514 43916
1000	235	483	272	11	clear	2500	5000	any	X-clip	10	13713X	9238 515 43916
1000	235	483	272	11	with white reflector	2400	5000	any	X-clip	10	13713X/98	9238 960 44516
2000	235	483	280	11	clear	2500	5000	any	X-clip	10	13168X	9238 525 43916
2000	235	483	280	11	with white reflector	2400	5000	any	X-clip	10	13168X/98	9245 742 44916
2000	400	625	416	11	clear	2450	5000	horizontal	X-clip	10	13245X	9238 530 57916
2000	400	625	416	11	with white reflector	2350	5000	horizontal	X-clip	10	13245X/98	9238 529 57916
2000	400	625	410	11	with white reflector	2350	5000	any	X-clip	10	13765X/98	9245 054 57916
2000	400	625	410	11	clear	2450	5000	any	X-clip	10	13765X	9238 531 57916
2000	400	483	282	11	clear	2700	5000	any	X-clip	10	14141X	9245 552 49116
3000	400	915	700	11	clear	2450	5000	horizontal	X-clip	10	13215X	9238 542 57916
3000	400	915	700	11	clear	2450	5000	any	X-clip	10	13230X	9238 540 57916
3000	400	915	700	11	with white reflector	2350	5000	any	X-clip	10	13230X/98	9238 541 57916

## HeLeN lamps X-clip

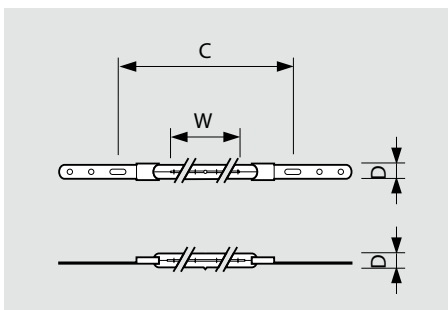

Short wave

Watt	Volt	Total length max mm (C)	Heating length mm (W)	Bulb diameter mm (D)	Tube	Colour temp. K	Average life h	Burning Position	Terminal	PU	Type no.	Article no.
1000	235	370	272	11	HeLeN coated	NA	5000	any	X-clip	10	15008X	9245 273 44516

### Standard lamps U-clip

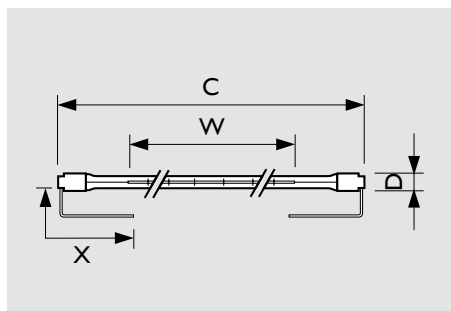

Short wave

Watt	Volt	Total length max mm (C)	Heating length mm (W)	Bulb diameter mm (D)	Tube	Colour temp. K	Average life h	Burning Position	Terminal	Wire mm (X)	PU	Type no.	Article no.
500	120	224	127	11	trans-lucent	2500	5000	horizontal	splice	146/146 not insulated	10	500T3	9245 176 36316
1000	235	346	270	11	clear	2500	5000	horizontal	splice	202/202 not insulated	10	13195U	9245 858 43916
1000	240	353	254	11	trans-lucent	2500	5000	horizontal	splice	146/146 not insulated	10	1000T3	9245 178 43816
1000	240	306	254	11	clear	2500	5000	horizontal	splice	146/146 not insulated	10	1000T3/CL	9245 179 43816
1200	144	220	155	11	clear	2400	5000	horizontal	fork	150/150 insulated	10/100	13561U	9245 859 57724
1200	144	220	155	11	with white reflector	2300	5000	horizontal	fork	150/150 insulated	1/20/100	13561U/98	9245 861 57716
1600	144	220	155	11	clear	2500	5000	horizontal	fork	150/150 insulated	10/100	13568U	9245 860 57724
1600	144	220	155	11	with white reflector	2400	5000	horizontal	fork	150/150 insulated	1/20/100	13568U/98	9245 862 57716
1600	240	503	406	11	clear	2500	5000	horizontal	splice	146/146 not insulated	10	1600T3/CL	9245 181 43816
1600	277	503	404	11	trans-lucent	2500	5000	horizontal	splice	146/146 not insulated	10	1600T3	9245 207 46916
2000	240	305	254	11	clear	2500	5000	any	splice	146/146 not insulated	10	2000T3/CL	9245 185 45516
2500	480	731	638	11	trans-lucent	2550	5000	horizontal	splice	146/146 not insulated	10	2500T3	9245 183 51616
2500	480	731	638	11	clear	2550	5000	horizontal	splice	146/146 not insulated	10	2500T3/CL	9245 264 51616
3800	575	1062	965	11	trans-lucent	2500	5000	horizontal	splice	146/146 not insulated	6	3800T3	9245 184 51116
3800	575	1062	967	11	clear	2500	5000	any	splice	146/146 not insulated	6	3800T3/CL/UB	9245 173 51116

### HeLeN lamps U-clip

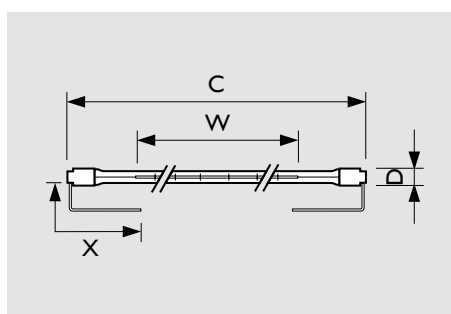

Short wave

Watt	Volt	Total length max mm (C)	Heating length mm (W)	Bulb diameter mm (D)	Tube	Colour temp. K	Average life h	Burning Position	Terminal	Wire mm (X)	PU	Type no.	Article no.
3000	235	503	423	11	HeLeN coated	NA	5000	any	splice	146/146 not insulated	10	15012U	9245 310 45524

## Standard lamps

## Facetted lamps

## Standard lamps V-cap

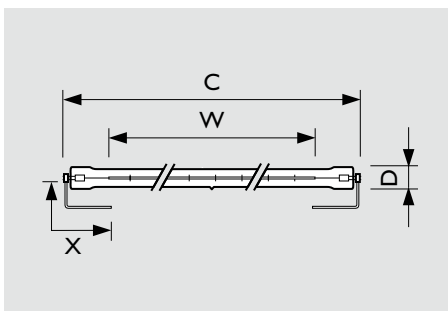

Short wave

Watt	Volt	Total length max mm (C)	Heating length mm (W)	Bulb diameter mm (D)	Tube	Colour temp. K	Average life h	Burning Position	Terminal	Wire mm (X)	PU	Type no.	Article no.
2000	235	350	280	11	clear	2450	5000	any	ring	117/138 insulated	10	13168V	9238 504 44516
2000	235	350	280	11	clear	2450	5000	any	splice	85/85 insulated	10	14189V	9245 799 44916
2500	235	350	284	11	clear	2450	5000	any	ring	117/138 insulated	10	14182V	9245 348 44916
2500	235	350	284	11	clear	2450	5000	any	splice	85/85 insulated	10	14190V	9245 800 44916
3000	235	350	277	13.5	clear	2400	5000	any	ring	117/138 insulated	10	13565V	9245 143 44506

## Facetted lamps V-cap

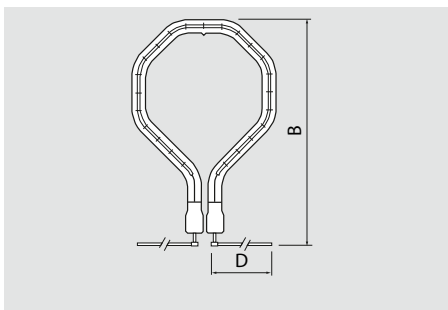
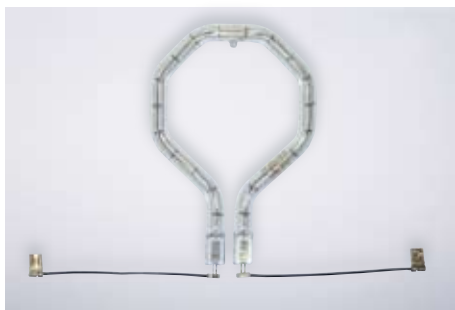

Short wave

Watt	Volt	Total length max mm (B)	Heating length mm	Bulb diameter mm	Tube	Colour temp. K	Average life h	Burning Position	Terminal	Wire mm (D)	PU	Type no.	Article no.
400	110	148	94	11	clear	2150	5000	horizontal	faston	105/105 insulated	25	13939F -V	9245 137 31926
400	230	148	94	11	clear	2250	5000	horizontal	faston	105/105 insulated	25	13939F-V	9245 137 44226





© Burda

© Solimagic

## DR. FISCHER infrared halogen lamps for Comfort Heating

An important field of use for infrared halogen lamps is comfort heating, the most efficient heating solution to increase wellbeing. Our infrared halogen lamps are suitable for use both inside and outside: on patios and in yards, in hotel rooms, in assembly halls and at workplaces in public buildings and even in large open spaces.

DR. FISCHER infrared halogen solutions, sold under the name "HeLeN", are perfect for enabling lifestyles, providing well-being and enhancing activities in an environmental friendly and sustainable way. The revolutionary HeLeN lamps are based on Philips' world-leading technology to meet specific demands of zone heating and other applications that require low glare. The HeLeN lamp consists of an infrared halogen lamp filament sealed in a specially developed quartz tube reducing the visible emission.

Here, infrared short waves guarantee comfortable warmth immediately the lamps are switched on. It is not the air that is heated, but the precise area where the warmth is required. Infrared halogen solutions are more energy saving, effective and precise than any other technology. Infrared halogen lamps can even be used for comfort heating in large areas such as churches, halls, warehouses or even open places such as sports facilities.

Heat lamps in infrared sauna cabins are primarily used for wellbeing. Although infrared cabins are utilized from a wellness angle as a rule, they also can improve physical wellness.

**As specialists in individual solutions, we are open to the requirements, wishes and ideas of our customers, which means we are glad to think about further possibilities of infrared use with you.**



© Tansun



© Burda



## Benefits of our Comfort Heating solutions

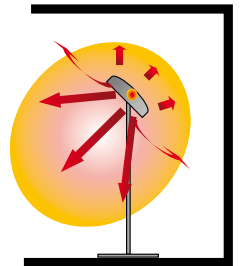
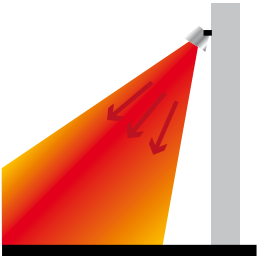

**Outdoor comfort heating:** restaurant and café terraces and all kinds of outdoor seating or waiting spaces.

**Indoor comfort heating:** heating in factories, sports halls, exhibition halls, work areas, warehouses, storage areas, garages, greenhouses, open-air applications, churches, stadiums, camp site, domestic heating...

**Infrared cabins and saunas**

**And many others ...**

This list is not exhaustive. Keep in mind that for all other needs we can help you and we will be happy to develop new applications with you. Do not hesitate to contact us for further information.

Lamps for comfort and direct heat	
Features	Benefits
Low glare	Natural colour output
Instant heat	Just switch on and get convenient energy-efficient heating when and where you need it
Direct heat	Warms the people and not the air, more comfort for less energy
Dimmable	Comfortable warmth which is adaptable to match the season

**The comfort heating range is:**

- Economic:** 90% of electricity converted into heat
  - Safe:** meets all standards (as a lamp)
  - Directional:** point the heater for heat exactly where you want it
  - Environment:** clean, no by-product, no oxygen consumption
  - Durable:** constant level of heat output (thanks to the halogen cycle)
- Noiseless and odorless**



## Outdoor applications

You can boost your activity thanks to efficient and well designed infrared halogen heating solutions. For instance, in fall, when weather conditions are very often changeable. So, in this period, terraces stay empty and your turnover suffers from it. This issue can easily be solved with our infrared halogen solutions. Straight away, you can

offer your clients the delight to seat and have a drink in an open-air place whatever the weather. Our outdoor infrared heating solutions will bring you lively terraces. Your clients will appreciate being comfortably seated even until late in the evening.

**DR. FISCHER infrared halogen lamps are efficient and well designed.**

### Areas of use

	Residential, Domestic private user	Hospitality, Commercial customer	Industrial, Professional worker, employee
Outdoor & Open Space	<ul style="list-style-type: none"> <li>• terrace</li> <li>• balcony</li> <li>• garden</li> <li>• swimming pool</li> </ul>	<ul style="list-style-type: none"> <li>• bar/restaurant terrace</li> <li>• commercial front entrance</li> <li>• stadium VIP stand</li> <li>• gas station pump-in</li> <li>• golf practice</li> <li>• transportation waiting booth</li> <li>• transportation waiting deck</li> <li>• queuing area (nightclub, ...)</li> <li>• car washing station</li> <li>• camping</li> <li>• market place</li> </ul>	<ul style="list-style-type: none"> <li>• working stations</li> <li>• logistic docks</li> <li>• smoking zone</li> <li>• substitute bench</li> </ul>

### Recommended lamps

Lamps for comfort and direct heat		
Application	Lamp	Special features of these DR. FISCHER lamps
For wet environments and applications with special confines	<b>Weatherproof HeLeN lamps</b> 	<ul style="list-style-type: none"> <li>• up market infrared halogen solution.</li> <li>• watertight cap: this finishing helps you reaching your desired IP certification against dust and water like IP 54 or even IP 65.</li> <li>• very low glare: doesn't hurt the eyes and allows a natural colour effect.</li> </ul>
For standard outdoor zone heating	<b>Standard HeLeN lamps</b> 	<ul style="list-style-type: none"> <li>• common infrared halogen solution.</li> <li>• very low glare: doesn't hurt the eyes and allows a natural colour effect.</li> </ul>
In case of standard replacement	<b>Economy Gold coated lamps</b> 	<ul style="list-style-type: none"> <li>• perfect infrared solution for less glare-sensitive uses</li> <li>• a very attractive price-performance ratio</li> </ul>



## Indoor applications

Sometimes it just doesn't make sense to turn up the temperature in the entire building when you just want to warm up one room you are in. It is expensive and not environmentally friendly. It is much better to use an additional heater. Infrared heater can be of great help. In addition, most heating systems work by warming the air in the room. People in the room are warmed by the air. Not only this wastes energy on warming up the air, but also you don't feel the benefits of the heater as soon as

it is switched on. It might take several minutes for a room to warm up. Our Infrared heating lamps work differently. They heat up directly where you need it. As a result people in the area are warmed directly by the heating system and not by the air. This principle makes our infrared halogen lamps very energy efficient. Another advantage is that you don't have to turn the heater on half an hour or hour in advance to pre-heat the room. You feel the warmth immediately.

**DR. FISCHER Vitae infrared lamps offer an optimized emission spectrum to heat the body and make people having a relaxing bodycare experience.**

### Areas of use

	Residential, Domestic private user	Hospitality, Commercial customer	Industrial, Professional worker, employee
Indoor & Enclosed Space	<ul style="list-style-type: none"> <li>• bathroom</li> <li>• living room</li> <li>• veranda/greenhouse</li> <li>• secondary room: DIY ...</li> </ul>	<ul style="list-style-type: none"> <li>• hotel bathroom</li> <li>• place of worship</li> <li>• sportareas</li> <li>• bar/restaurant veranda</li> <li>• queuing area (cashier area, ...)</li> <li>• swimming pool</li> <li>• camping</li> <li>• market place</li> <li>• maternity (new-born warming)</li> </ul>	<ul style="list-style-type: none"> <li>• automobile repair shops</li> <li>• working station</li> <li>• substitute bench</li> </ul>

### Recommended lamps

Lamps for comfort and direct heat		
Application	Lamp	Special features of these DR. FISCHER lamps
For wet environments and applications with special confines	<b>Weatherproof HeLeN lamps</b> 	<ul style="list-style-type: none"> <li>• up market infrared halogen solution.</li> <li>• watertight cap: this finishing helps you reaching your desired IP certification against dust and water like IP 54 or even IP 65.</li> <li>• very low glare: doesn't hurt the eyes and allows a natural colour effect.</li> </ul>
For standard outdoor zone heating	<b>Standard HeLeN lamps</b> 	<ul style="list-style-type: none"> <li>• common infrared halogen solution.</li> <li>• very low glare: doesn't hurt the eyes and allows a natural colour effect.</li> </ul>
In case of standard replacement	<b>Economy Gold coated lamps</b> 	<ul style="list-style-type: none"> <li>• perfect infrared solution for less glare-sensitive uses</li> <li>• a very attractive price-performance ratio</li> </ul>

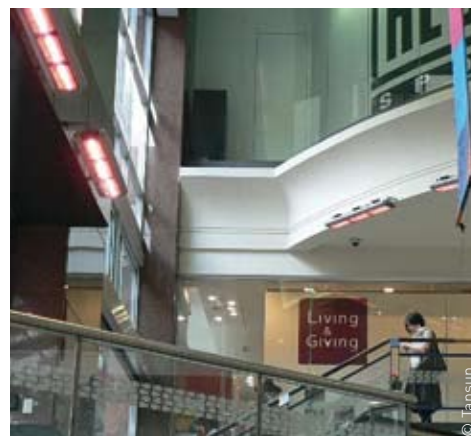

## Infrared cabins & saunas

We live in a more and more urban and contaminated environment. Gas emissions from cars, factories, power stations etc. produce harmful substances. These toxins are stored by our body and may create some symptoms. Sweating is one of the solutions to eliminate toxic absorptions and purify our body. By reflex responses to heat exposure, such as expanding blood vessels in the skin, our sweat glands are stimulated and

the skin is warmed to a depth and gentle way without discomfort as is caused by sunrays. By emitting penetrated infrared rays, it is possible to feel gentle warmth which allows a high sweating, relaxing and soothing effect. It has been demonstrated that physical relaxation enables the elimination of stress and anxiety. DR. FISCHER Vitae infrared halogen lamps are designed for creating well-being experiences

such as laying into infrared cabins or saunas. These highly technological lamps give health and beauty centers the opportunity to offer an innovative, rapid and convenient service. DR. FISCHER Vitae infrared halogen lamps have numerous benefits for body heating like a warm feeling with an efficient, direct and gentle heat.

### Areas of use

Residential, Domestic private user	Hospitality, Commercial customer
Infrared cabins & saunas	<ul style="list-style-type: none"> <li>• Therapy centres</li> <li>• Fitness centres</li> <li>• Spas centres</li> <li>• And many more...</li> </ul>



### Recommended lamps: Vitae Lamps

DR. FISCHER Vitae infrared halogen lamps are designed for body relaxation applications such as infrared cabins. These lamps are based on a world-leading technology, allowing operators to deliver a better and faster service, more conveniently, in less space. DR. FISCHER infrared halogen lamps deliver the optimum balance across the infrared emission spectrum.

In addition, the lamp emissions reach the subcutaneous layer of the skin (see graph: Depth of penetration into the skin), where heat is dissipated more efficiently. This gives a more diffuse and pleasant warming effect. DR. FISCHER lamps provide direct body heating, matching the characteristics of the skin

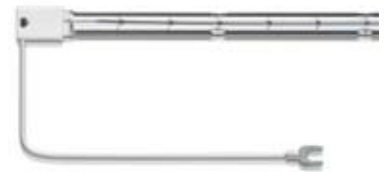

Lamps for comfort and direct heat	
Features	Benefits
Medium wave technology	Optimal penetration into skin and muscles for an ultimate result
Instant heat	No preheating needed for shorter, more effective sessions and higher energy efficiency

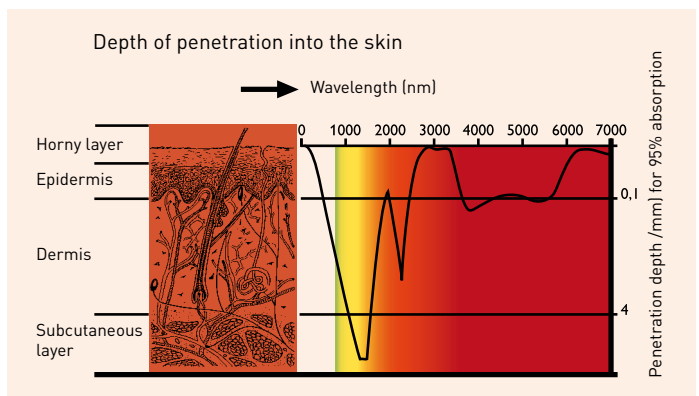

## Infrared halogen lamps for Comfort Heating applications

### HeLeN Lamps

The DR. FISCHER infrared halogen lamps are based on world-leading technology HeLeN. This specific lamp is designed to meet your specific low glare requirements for comfort heating and for applications where visible light level should be lowered.

DR. FISCHER infrared halogen lamps with HeLeN technology are:

- simple
- flexible
- effective
- reliable
- comfortable
- economical

This makes the difference in the world of comfort heating.

### Weatherproof HeLeN

Let's go outside...

The SK15 cap is made robust upon outside conditions and especially water splash. This specific finishing helps you reaching your desired IP certification against dust and water, like IP54 or even IP65.

Design-in is simplified, for instance, a heater front-glass could become extra and less effort is necessary to protect the caps. As a result, you can lower your heater housing costs.

### Standard HeLeN

Most common infrared halogen solutions for a very low glare effect and optimal efficiency.

### Economy Gold Coated lamps

Inspired of the HeLeN technology these lamps are specially manufactured to target the replacement market.

### Vitae lamps

The lamp emissions reach the subcutaneous layer of the skin where heat is dissipated more efficiently. This gives a more diffuse and pleasant warming effect.

DR. FISCHER Vitae lamps are, like DR. FISCHER HeLeN lamps, infrared halogen lamps. But Vitae lamps have a colour temperature range of between 1750K and 2000K. They can already almost be considered medium wave emitters because they emit more medium wave infrared than HeLeN lamps do, for instance.



As a result, the balance between short and medium IR for a Vitae lamp is perfectly suited to body heating, combining as it does the heat effect (skin penetration by short IR) and heat feeling (given by medium-wave IR to warn against excess heat).

Because of their low colour temperature, (below 2000 °K), DR. FISCHER Vitae lamps only emit low amounts of visible light, even without a coating. Another peculiarity of Vitae lamps is their linear power spectrum, which ranges from a comparatively low 300 W up to 1300 W.





## Overview of applications

Application	Lamp solution
Outdoor spaces	Weatherproof and Standard HeLeN
Wet environment	Weatherproof HeLeN
Indoor spaces	Standard HeLeN and Eco gold coated
Replacement market	Standard HeLeN and Eco gold coated
Infrared cabins	Vitae
Bodycare application	Standard HeLeN and Vitae

## Overview of caps

Cap type	
SK 15 SK 15 Wheatherproof	
R7s	
U-clip	

## Overview of connections

Wire with	
Splice	
Fork	
Faston	
Insulated tab	
Tab	

## Weatherproof HeLeN lamps

## Weatherproof HeLeN SK 15

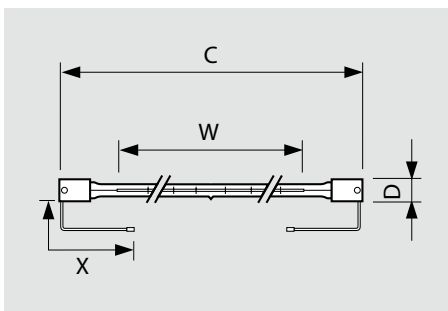

Short wave

Watt	Volt	Total length max mm (C)	Heating length mm (W)	Bulb diameter mm (D)	Luminous flux max lm	Average life h	Burning Position	Terminal	Wire mm (X)	PU	Type no.	Article no.
500	235	226	165	11	150	5000	horizontal	splice	150/500 insulated	10	15084Z	9245 849 44916
1000	235	355	280	11	280	5000	any	splice	400/400 double insulated	10	15058Z	9245 801 44916
1000	235	355	272	11	280	5000	horizontal	splice	150/500 insulated	10	15070Z	9245 803 44916
1000	235	355	272	11	280	5000	horizontal	faston	200/600 double insulated	10	15081Z	9245 844 44917
1000	235	355	280	11	280	5000	any	splice	500/500 insulated	10	15078Z	9245 840 36316
1000	235	355	272	11	280	5000	any	splice	500/500 insulated	10	15079Z	9245 840 44916
1000	235	355	272	11	280	5000	any	splice	600/600 double insulated	10	15090Z	9245 865 44916
1300	235	355	280	11	440	5000	any	splice	600/600 double insulated	10	15094Z	9245 869 44916
1500	120	355	280	11	330	5000	any	splice	600/600 double insulated	10	15093Z	9245 868 36316
1500	235	355	280	11	350	5000	horizontal	splice	150/500 insulated	10	15042Z	9245 834 44916
1500	235	355	280	11	350	5000	horizontal	faston	200/600 double insulated	10	15082Z	9245 845 44917
1500	235	355	280	11	350	5000	any	splice	150/500 insulated	10	15050Z	9245 836 44916
1500	235	355	180	11	350	5000	any	splice	400/400 double insulated	10	15059Z	9245 798 44916
1500	235	355	280	11	350	5000	any	splice	500/500 insulated	10	15080Z	9245 841 44916
1500	235	355	280	11	350	5000	any	splice	600/600 double insulated	10	15091Z	9245 866 44916
2000	235	355	280	11	450	5000	horizontal	splice	150/500 insulated	10	15043Z	9245 835 44916
2000	235	355	280	11	450	5000	horizontal	faston	200/600 double insulated	10	15083Z	9245 846 44917
2000	235	355	280	11	450	5000	any	splice	150/500 insulated	10	15051Z	9245 837 44916
2000	235	355	280	11	450	5000	any	splice	400/400 double insulated	10	15057Z	9245 802 44916
2000	235	355	280	11	450	5000	any	splice	600/600 double insulated	10	15092Z	9245 867 44916



## Standard HeLeN SK 15

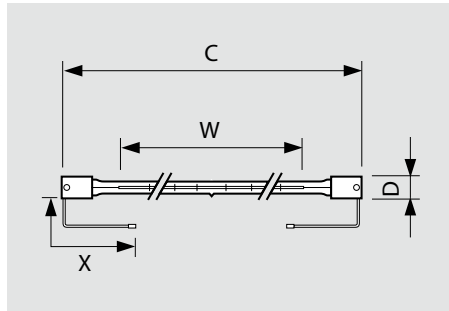

Short wave

Watt	Volt	Total length max mm (C)	Heating length mm (W)	Bulb diameter mm (D)	Luminous flux max lm	Average life h	Burning Position	Terminal	Wire mm (X)	PU	Type no.	Article no.
1000	120	355	280	11	330	5000	any	faston	300/300 double insulated	10	15049Z	9245 751 36316
1000	235	355	272	11	280	5000	horizontal	faston	300/300 double insulated	10	15007Z	9245 242 45516
1000	235	355	272	11	280	5000	any	faston	900/900 insulated	10	15009Z	9245 274 44916
1100	230	532	446	11	270	5000	any	insulated tab	85/85 insulated	10	15026Z	9245 467 44216
1500	120	355	280	11	330	5000	horizontal	fork	300/300 double insulated	10	15015Z	9245 338 31916
1500	235	355	280	11	350	5000	horizontal	splice	300/500 double insulated	10	15067Z	9245 795 44916
1500	235	355	280	11	350	5000	horizontal	faston	300/300 double insulated	10	15004Z	9245 231 45516
1500	235	355	280	11	350	5000	any	faston	300/300 double insulated	10	15034Z	9245 567 44916
1500	235	359	280	11	350	5000	horizontal	tab	-	10	15004CF	9245 655 44944
1500	240	355	280	11	350	5000	horizontal	fork	300/300 double insulated	10	15010Z	9245 297 45516
2000	235	355	280	11	450	5000	horizontal	splice	140/140 double insulated	10	15060Z	9245 781 44916
2000	235	355	272	11	280	5000	horizontal	splice	300/500 double insulated	10	15066Z	9245 794 44916
2000	235	355	280	11	350	5000	horizontal	splice	300/500 double insulated	10	15068Z	9245 796 44916
2000	235	355	280	11	450	5000	horizontal	faston	300/300 double insulated	10	15005Z	9245 244 45516
2000	235	355	280	11	450	5000	any	faston	300/300 insulated	20	15021Z	9245 443 44916
2000	235	532	446	11	700	5000	any	insulated tab	85/85 double insulated	10	15045Z	9245 746 44916

## Standard HeLeN lamps Economy Gold lamps

### Standard HeLeN R7s

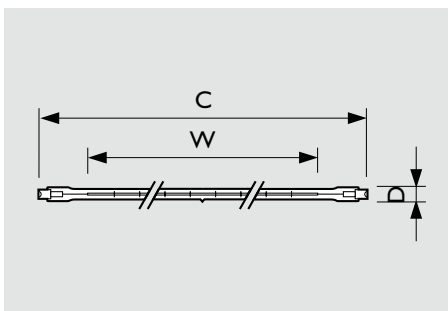

Short wave

Watt	Volt	Total length max mm (C)	Heating length mm (W)	Bulb diameter mm (D)	Luminous flux max lm	Average life h	Burning Position	Terminal	Wire mm	PU	Type no.	Article no.
1000	235	352	280	11	280	5000	horizontal	splice	155/155 double insulated	10	15072C	9245 807 44916
1200	120	254	185	11	330	2000h	horizontal	R7s	-	40	15025R	9245 460 36302
1200	120	254	185	11	330	2000h	horizontal	R7s	-	10	15025R	9245 460 36316
1300	240	254	185	11	440	2000h	horizontal	R7s	-	40	15028R	9245 460 45502
1500	235	352	280	11	330	5000	horizontal	-	15/15 not insulated	10	15053C	9245 769 44916
1500	235	352	280	11	350	5000	horizontal	splice	155/155 double insulated	10	15071C	9245 805 44916
1500	235	353	280	11	350	5000	any	semi-strip	153/503 insulated	10	15076C	9245 838 44916
1500	240	351	280	11	350	5000	horizontal	R7s	-	10	15030R	9245 498 45525

### Economy Gold R7s

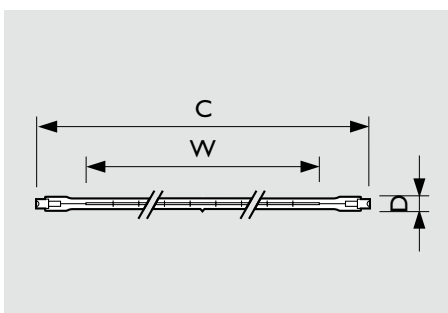

Short wave

Watt	Volt	Total length max mm (C)	Heating length mm (W)	Bulb diameter mm (D)	Luminous flux max lm	Average life h	Burning Position	Terminal	PU	Type no.	Article no.
1200	120	254	185	11	1200	2000	horizontal	R7s	40	15089R	9245 864 36302
1300	240	254	185	11	1500	2000	horizontal	R7s	40	15085R	9245 853 45502

### Specific remarks on HeLeN lamps:

The burning lamp must be used at:

- A pinch temperature  $\leq 350$  °C/662°F
- 250 °C (482°F)  $\leq$  bulb temperature  $\leq 800$  °C/1472°F

**Please note:** Infrared HeLeN lamps are sensitive to specific chemicals, like chloride or ammonia, which may affect lamp outlook.

## Vitae lamps SK 15

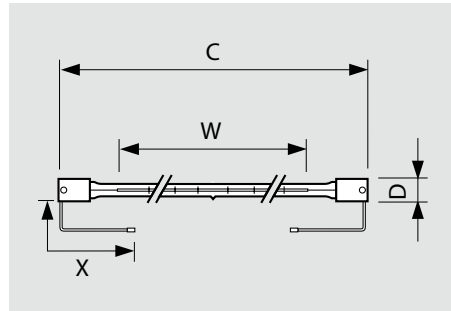

Medium wave

Watt	Volt	Total length max mm (C)	Heating length mm (W)	Bulb diameter mm (D)	Tube	Colour temp. K	Average life h	Burning Position	Terminal	Wire mm (X)	PU	Type no.	Article no.
300	120	433	380	11	clear	1850	5000	any	splice	100/600 insulated	10	14181Z	9245 761 36316
350	235	628	550	11	translucent	1750	5000	any	splice	230/1200 insulated	10	14169Z	9245 700 44916
500	235	787	700	11	translucent	1800	5000	any	splice	230/1200 insulated	10	14142Z	9245 556 44916
500	235	628	550	11	translucent	1800	5000	any	splice	230/1200 insulated	10	14157Z	9245 629 44916
750	230	787	700	11	clear	2000	5000	any	splice	230/1200 insulated	10	14117Z	9245 405 44216
750	230	787	700	11	translucent	1750	5000	any	splice	230/1200 insulated	10	14124Z	9245 479 44216
750	230	787	700	11	clear	1750	5000	any	splice	230/1200 insulated	10	14155Z	9245 622 44216
1300	235	787	700	11	clear	2000	5000	any	fork	200/200 insulated	10	13393Z	9239 454 44516

## Range of accessories, system and custom solutions

When designing an infrared heater, it is highly important to check that its performance matches the requirements of the application. To help OEMs to assess and optimize the quality level of their heating system, DR. FISCHER application team proposes specific measurement, modeling, design and a range of accessories and sub-systems.

Aluminum reflectors for one Quartz Infrared Halogen Lamp supplied with two screws for easy mounting on customized frame. High infrared reflective material above 90 %. Infrared radiation can be directed specifically at the object. Light and cost effective heating systems. Easy mounting and easy maintenance. Can be component for bigger radiant unit.

Reflector units suitable for one Quartz Infrared Halogen Lamp of either 500 W or 1000 W with SK15/Z cap. The lamps fit in holders on each side of the unit.

Highly efficient parabolic reflector for 20 to 30 cm distances, made of anodized aluminum. Its orange peel surface structure smoothen the irradiance curve of the heat distribution. Its special design (shape and surface) achieves the most homogeneous irradiance over the heated surface in combined reflector arrangement: multiple crosswise or staggered installation.

### Applications

- New design and prototyping of any heating solutions
- Plastic thermoforming
- Textile industry: drying textile materials
- Floor covering: heat treatment of carpets and various floor covering

DR. FISCHER has also the capability to provide complete solution and new generation of system in different technologies. Our expertise can support you and your business with customized solutions.



## Logos description



Preferably do not touch quartz with bare hands. If grease or chemical compound have been deposited on quartz, simply clean before lighting with cloth moistened with alcohol.

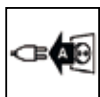

Disconnect installation from power supply before removing or installing a lamp.

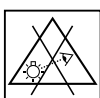

Prolonged looking at the lamp during operation may result in damage to the eye.



Keep dry.



Weatherproof



Non Household

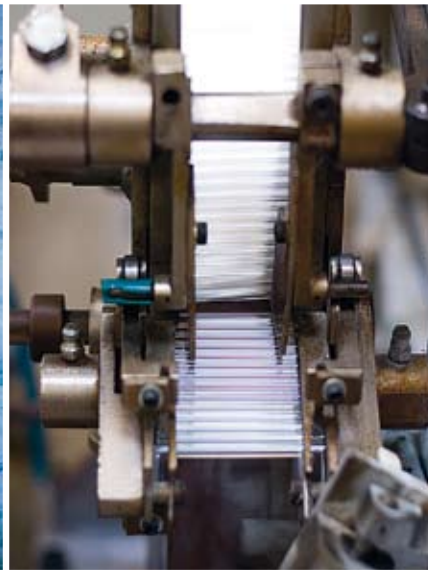
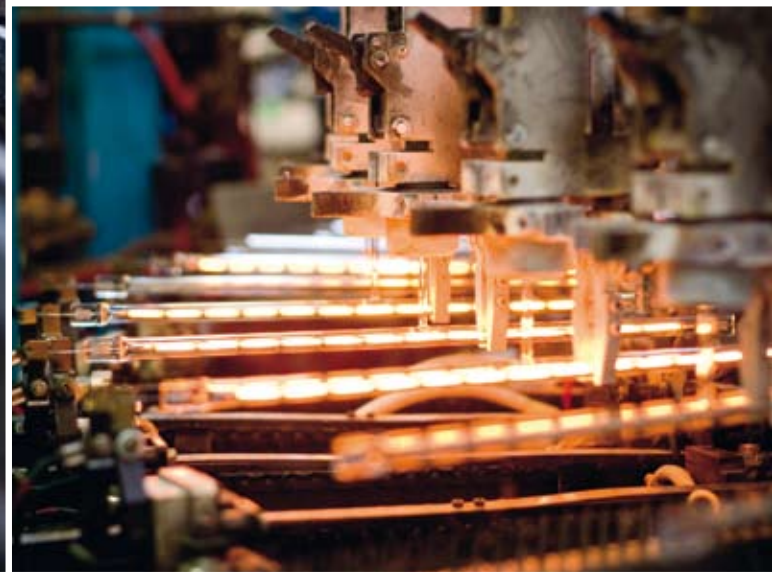





**DR. FISCHER**  
Europe S.A.S.

Chemin de Montrichard  
54700 Pont à Mousson  
FRANCE  
Tel.: +33 (0) 3 83 80 30 60  
Fax: +33 (0) 3 83 80 30 48  
Internet: [www.dr-fischer-group.com](http://www.dr-fischer-group.com)  
eMail: [pam.orderdesk@dr-fischer-group.com](mailto:pam.orderdesk@dr-fischer-group.com)



**DR. FISCHER**  
Asia Pacific Ltd.

#93-8 Pyongchang-dong, Jongro-gu  
110-846 Seoul  
KOREA  
Tel: +82 (0) 70 86 66 16 37  
Fax: +82 (0) 70 82 82 16 36  
Internet: [www.dr-fischer-group.com](http://www.dr-fischer-group.com)  
eMail: [asia-pacific.orderdesk@dr-fischer-group.com](mailto:asia-pacific.orderdesk@dr-fischer-group.com)



**DR. FISCHER**  
Group

Nikolaus-Otto-Straße  
D - 65582 Diez / Lahn  
GERMANY  
Tel.: +49 (0) 64 32 / 91 31 31  
Fax: +49 (0) 64 32 / 91 31 41  
Internet: [www.dr-fischer-group.com](http://www.dr-fischer-group.com)  
eMail: [diez.orderdesk@dr-fischer-group.com](mailto:diez.orderdesk@dr-fischer-group.com)

Sales partners:

A large white rectangular area with rounded corners, intended for listing sales partners.